

FRACARRO



MADE IN ITALY

LP45F LTE

cod. 216249

- I ANTENNE LOGARITMICHE PERIODICHE A LARGA BANDA
- EN BROAD BAND LOG-PERIODIC ANTENNAS
- FR ANTENNES LOGARITHMIQUES PERIODIQUES A LARGE BANDE
- E ANTENAS LOGARITMICAS PERIODICAS DE BANDA ANCHA

I Avvertenze per la sicurezza: L'installazione del prodotto deve essere eseguita da personale qualificato in conformità alle leggi e normative locali sulla sicurezza.
EN Safety warnings: The product must only be installed by qualified persons, according to the local safety standards and regulations.
FR Avertissements de sécurité: L'installation du produit doit être effectuée par du personnel qualifié conformément aux lois et aux normes locales sur la sécurité.
E Advertencias de seguridad: La instalación del producto tiene que realizarla personal cualificado de conformidad con las leyes y las normativas locales de seguridad.

I Angoli appuntiti
EN Sharp Edges
FR Partie pointue
E Parte apuntada

I Per la vostra sicurezza utilizzate occhiali protettivi all'installazione
EN For your safety, use protective glasses during installation
FR Pour votre sécurité, utilisez des lunettes de protection lors de l'installation
E Para su seguridad, use gafas protectoras durante la instalación

max 2 mm

75 Ohm

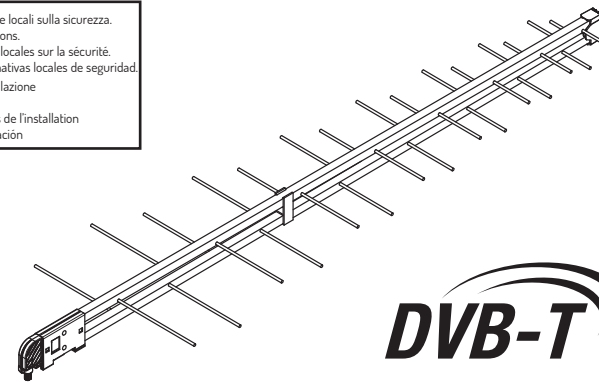
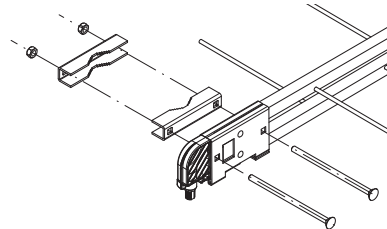
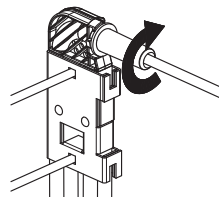
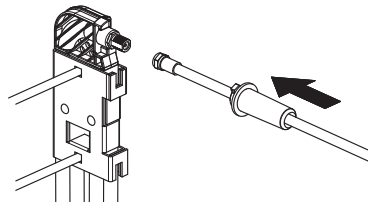

DVB-T

- I ORIZZONTALE
- EN HORIZONTAL
- FR HORIZONTAL
- E HORIZONTAL

H

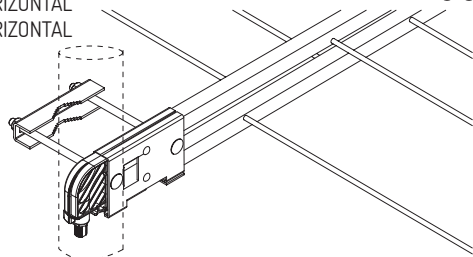

- I VERTICALE
- EN VERTICAL
- FR VERTICAL
- E VERTICAL

V

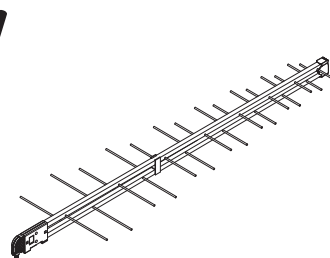
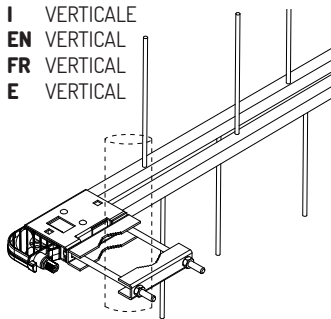

Ø 25 mm
Min.

Ø 60 mm
Max

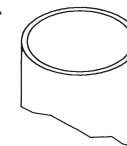

- I COPPIA DI SERRAGGIO DEI BULLONI
 - EN DRIVING TORQUE
 - FR COUPLE DE SERRAGE DES BOULONS
 - E PAR DE FUERZAS NECESARIA PARA APRETAR LAS TUERCAS
- Min 400 Ncm
Max 600 Ncm

Fracarro Radioindustrie SRL - Via Cazzaro n.3 - 31033 Castelfranco Veneto (TV) - ITALIA - Tel: +39 0423 7361 - Fax: +39 0423 736220
Fracarro France S.A.S. - 7/14 rue du Fossé Blanc Bâtiment C1 - 92622 Gennevilliers Cedex - FRANCE Tel: +33 1 47283400 - Fax: +33 1 47283421
Fracarro (UK) - Ltd - Suite F9A, Whiteleaf Business Centre, Little Balmer, Buckingham, MK18 1TF UK - Tel: +44(0)1908 571571 - Fax: +44(0)1908 571570
www.fracarro.com - info@fracarro.com - supportotecnico@fracarro.com - chat whatsapp +39 335 7762667



Manufacturer: Fracarro Radioindustrie SRL Via C. Cazzaro, 3 - 31033 Castelfranco Veneto - Treviso - Italy

Fracarro declares that the product complies with EU Directive 2011/65/UE.
The full text of the EU Declaration of Conformity is available on the following website ce.fracarro.com.